



Characteristics



- Energy saving heat pump air curtains: Up to 70% reduction in costs and CO₂ emissions (heating mode).
- Compact and low profile recessed air curtain with full grille view.
- Self-supporting casing construction made of galvanized steel plate, ready to be installed recessed in a false ceiling.
- Inlet grille (free of maintenance) made with aluminium profiles and blow-out nozzle, integrated in a single white frame colour RAL 9016. Other colours are available on request.
- EC Double-inlet centrifugal fans driven by an external rotor motor and low noise level, with very low consumption efficient fans.
- Includes direct expansion coil with sensors. Optional condensate water pump.
- CS-5DX-NE Plug&Play control with 5 speeds and telephone cable 7m included.
- Requires HITACHI DX Interface KIT adapted for air curtain with expansion valve and programmable control, please consult.
- Ready to connect to HITACHI Inverter outdoor heat pump unit (R410A), not included, the customer should purchase it.

Specifications

Model	Airflow m ³ /h	Outdoor Unit 230Vx1	Outdoor Unit 400Vx3	Hitachi Kit Interface DX (*)	Power Fans 230V-50Hz kW	Current Fans 230V-50Hz A	Noise Level (5 m) dB(A)	Weight kg
RDAM ECM 1000 DX8-HI	1640	RAS-3HVNC1	-	EXV-3.0E2	0,142	1,24	56	50
RDAM ECM 1500 DX11-HI	2460	RAS-4HVNC1E	RAS-4HNC1E	EXV-4.0E2	0,213	1,86	57	74
RDAM ECM 2000 DX16-HI	3280	RAS-6HVNC1E	RAS-6HNC1E	EXV-6.0E2	0,284	2,48	58	95
RDAM ECM 2500 DX21-HI	4100	-	RAS-8HNCE	EXV-8.0E2	0,355	3,10	59	106
RDAM ECG 1000 DX8-HI	2190	RAS-3HVNC1	-	EXV-3.0E2	0,213	1,86	61	55
RDAM ECG 1500 DX13-HI	2920	RAS-5HVNC1E	RAS-5HNC1E	EXV-5.0E2	0,284	2,48	62	80
RDAM ECG 1500 DX15-HI	2920	RAS-6HVNC1E	RAS-6HNC1E	EXV-6.0E2	0,284	2,48	62	80
RDAM ECG 2000 DX22-HI	4380	-	RAS-8HNCE	EXV-8.0E2	0,426	3,72	63	105
RDAM ECG 2500 DX22-HI	5110	-	RAS-8HNCE	EXV-8.0E2	0,497	4,34	64	114
RDAM ECG 2500 DX28-HI	5110	-	RAS-10HNCE	EXV-10.0E2	0,497	4,34	64	114

(*) Includes direct expansion valve.

HITACHI Utopia IXV Confort (*) Outdoor Units	Heating Capacity kW	Heating Power kW	SCOP or COP	Cooling Capacity kW	Cooling Power kW	SEER or EER	Power Supply	Pipes Gas Liquid inch	Pipes Maximum Length m	Pipes Maximum Height m
RAS-3HVNC1	8,0	2,00	4,00	7,1	2,26	3,14	230Vx1	5/8 3/8	50	30
RAS-4HVNC1E	11,2	2,45	4,57	10,0	2,70	3,70	230Vx1	5/8 3/8	70	30
RAS-4HNC1E	11,2	2,45	4,57	10,0	2,70	3,70	400Vx3	5/8 3/8	70	30
RAS-5HVNC1E	14,0	3,60	3,89	12,5	3,71	3,37	230Vx1	5/8 3/8	75	30
RAS-5HNC1E	14,0	3,60	3,89	12,5	3,71	3,37	400Vx3	5/8 3/8	75	30
RAS-6HVNC1E	16,0	4,29	3,73	14,0	4,29	3,26	230Vx1	5/8 3/8	75	30
RAS-6HNC1E	16,0	4,29	3,73	14,0	4,29	3,26	400Vx3	5/8 3/8	75	30
RAS-8HNCE	22,4	5,88	3,81	20,0	5,95	3,36	400Vx3	1 3/8	100	30
RAS-10HNCE	28,0	7,71	3,63	25,0	8,28	3,02	400Vx3	1 1/2	100	30

(*) Also compatible with outdoor units Utopia ES, VRF Centrifugal, Utopia IXV Premium.

Energy efficiency: SCOP/SEER seasonal ≤12kW, COP/EER >12kW.

Outdoor unit capacities depending on standard conditions: heating 20°CDB indoor / 7°CDB and 6°CWB outdoor, cooling 27°CDB and 19°CWB indoor / 35°CDB outdoor.

When adverse weather conditions, the outdoor unit capacity can decrease. It is recommendable to oversize the units.



Characteristics



- Energy saving heat pump air curtains: Up to 70% reduction in costs and CO₂ emissions (heating mode).
- Compact and low profile recessed air curtain with full grille view.
- Self-supporting casing construction made of galvanized steel plate, ready to be installed recessed in a false ceiling.
- Inlet grille (free of maintenance) made with aluminium profiles and blow-out nozzle, integrated in a single white frame colour RAL 9016. Other colours are available on request.
- EC Double-inlet centrifugal fans driven by an external rotor motor and low noise level, with very low consumption efficient fans.
- Includes direct expansion coil with sensors. Optional condensate water pump.
- CS-5DX-NE Plug&Play control with 5 speeds and telephone cable 7m included.
- Requires HITACHI VRF Interface KIT adapted for air curtain with expansion valve and programmable control, please consult.
- Ready to connect to HITACHI VRF outdoor heat pump unit (R410A), not included, the customer should purchase it.

Specifications

Model	Airflow m ³ /h	Hitachi Kit Interface VRF (*)	Power Fans 230V-50Hz kW	Current Fans 230V-50Hz A	Noise Level (5 m) dB(A)	Weight kg
RDAM ECM 1000 VRF8-HI	1640	EXV-3.0E2	0,142	1,24	56	50
RDAM ECM 1500 VRF12-HI	2460	EXV-4.0E2	0,213	1,86	57	74
RDAM ECM 2000 VRF16-HI	3280	EXV-6.0E2	0,284	2,48	58	95
RDAM ECM 2000 VRF19-HI	3280	EXV-8.0E2	0,284	2,48	58	95
RDAM ECM 2500 VRF21-HI	4100	EXV-8.0E2	0,355	3,10	59	106
RDAM ECM 2500 VRF24-HI	4100	EXV-10.0E2	0,355	3,10	59	106
RDAM ECG 1000 VRF10-HI	2190	EXV-4.0E2	0,213	1,86	61	55
RDAM ECG 1500 VRF13-HI	2920	EXV-5.0E2	0,284	2,48	62	80
RDAM ECG 1500 VRF15-HI	2920	EXV-6.0E2	0,284	2,48	62	80
RDAM ECG 2000 VRF20-HI	4380	EXV-8.0E2	0,426	3,72	63	105
RDAM ECG 2000 VRF24-HI	4380	EXV-8.0E2	0,426	3,72	63	105
RDAM ECG 2500 VRF25-HI	5110	EXV-8.0E2	0,497	4,34	64	114
RDAM ECG 2500 VRF29-HI	5110	EXV-10.0E2	0,497	4,34	64	114

(*) Includes direct expansion valve.

HITACHI VRF Outdoor Units

Utopia ES / Utopia IVX Confort

VRF Centrifugal

Utopia IVX Premium / Set Free Mini / Front Flow

Set Free



When adverse weather conditions, the outdoor unit capacity can decrease. It is recommendable to oversize the units.



Dimensions

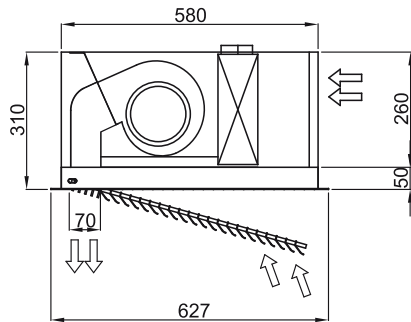
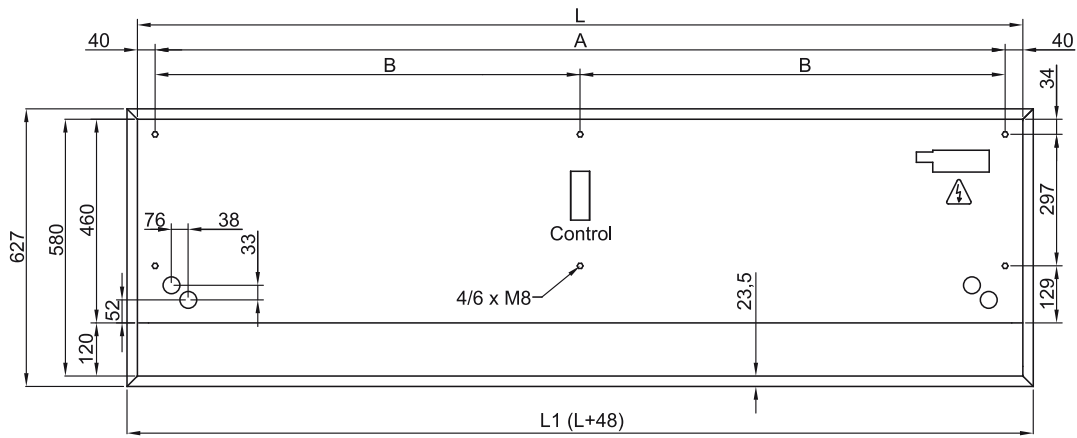

	L	L1	A	B
RDAM 1000	1000	1048	920	-
RDAM 1500	1500	1548	1420	710
RDAM 2000	2000	2048	1920	960
RDAM 2500	2500	2548	2420	1210

Finishes and details



Detail of exposed inlet grille

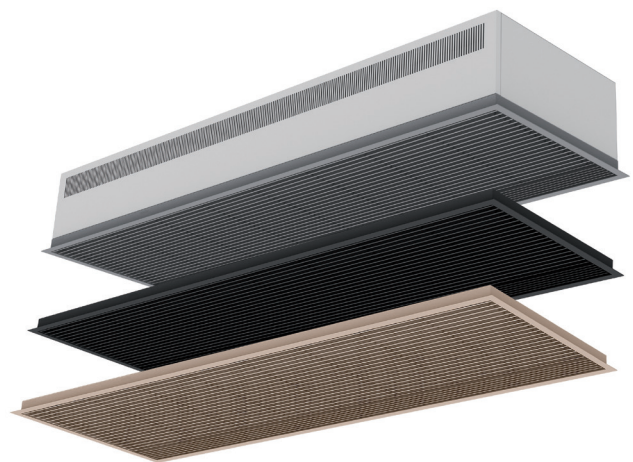

Customizable inlet grille in RAL color optionally